



# AGILENT TPS TURBO PUMPING SYSTEMS

- 2-4 Features and Benefits
- 5 Typical Applications
- 6-7 TPS-mini
- 8-9 TPS-compact
- 10-12 TPS-bench
- 13-15 TPS-mobile



Agilent Technologies

# AGILENT TPS - TURBO PUMPING SYSTEMS

## THE NEW INTEGRATED PUMPING SOLUTIONS WITH TWISTORR FS TECHNOLOGY

Powered by Agilent TwisTorr Turbomolecular pumps and backed by Agilent Dry Scroll or Rotary Vane Pumps.

### TPS-mini

Portable, dry system with the smallest footprint, featuring the new TwisTorr 84 FS.

### TPS-compact

TwisTorr 304 FS: best vacuum performance, fast pumpdown time, integrated IDP-3 Dry Scroll Pump.

### TPS-bench

Table-top solutions, backed by Agilent Dry Scroll Pump or Rotary Vane Pump.

### TPS-mobile

Roll-around carts, high capacity systems, wide pumping speed range.

Customized configurations on request



#### IDP-3 Dry Scroll Pump

- The most compact and light scroll pump in the market
- Innovative hermetic design, with motor and bearings outside the vacuum space
- Integrated pump isolation valve
- Cost effective and easy tip-seal replacement



#### Design for Reliability

- A rigorous test regime of product performance, reliability and durability according to Agilent standards
- Environmental Test method (Shock, Humidity, Noise, Temperature, Vibration Tests)
- Reliability assessment on Agilent systems
- Vacuum Test, Life Tests

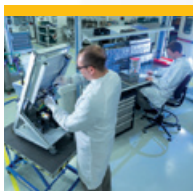

#### Manufacturing

- New TPS Manufacturing Line in Agilent Vacuum Products plant in Torino, Italy

#### Service and Support

- Several levels of Service Programs to help you maximize your productivity: Advance Exchange, Upgrade Program, Factory Repair, Field Support



#### Active Gauge Capability

- FRG-700 Active Full Range combined gauge: Pirani and Cold Cathode from atmosphere to  $5 \times 10^{-9}$  mbar ( $7 \times 10^{-9}$  Torr)
- Pressure data available on three independent channels:
  - Serial communication
  - Analog output
  - On board display

# TPS TURBO PUMPING SYSTEMS



## On Board Direct Pressure Reading

- Large pressure reading display
- Torr, Pascal and mbar options
- Ready for FRG-700 Active Gauge



## IDP-15 Dry Scroll Pump

- The next generation 15 m<sup>3</sup>/h scroll pump, designed for quiet and low vibration operation

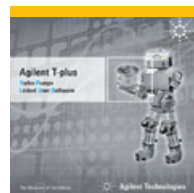

## User-friendly Interface

- T-Plus software for full PC/Laptop control enables easy data download and graphic display



Turbo Pumping Systems

## TwisTorr FS Technology

### High Performance, Innovation, Reliability

#### Agilent

#### Floating Suspension, to ensure:

- Low vibration and acoustical noise
- Extended bearings operating life
- Exceptional stability for demanding applications



#### Unique TwisTorr stages to deliver the best vacuum performance available:

- High pumping speed and compression ratio
- High throughput, high foreline tolerance
- Low power consumption, low operating temperature



TwisTorr 304 FS

TwisTorr 84 FS



# AGILENT TPS - TURBO PUMPING SYSTEMS

## THE NEW INTEGRATED PUMPING SOLUTIONS WITH TWISTORR FS TECHNOLOGY

### The new TPS Turbo Pumping Systems: just plug and pump!

Portable, fully integrated vacuum solutions, available as light dry bench-top solutions, for small and medium volumes, or high capacity, wide pumping speed range cart versions.

Now available with the innovative, breakthrough TwisTorr FS Turbo Pumps, for outstanding performance and reliability.

### Turbo Pumping Systems: key features

Integrated, complete vacuum systems

- Wide range from bench-top to cart versions
- Flexible: broad choice of gauges, valves and components
- Compact and portable: small footprint, light weight
- Enhanced, reliable vacuum performance
- Easy-to-use, simply plug and pump!
- Cost-effective solutions
- Worldwide power configurations and safety standards
- Global Technical, Application and Customer Service support
- Advance Exchange, Upgrade and Repair programs available
- Dry versions: no hydrocarbon contamination, no oil leaks
- **Improved performance and reliability with the new TwisTorr FS pumps**

## Innovative Vacuum Technologies for Your System



### Agilent Rotary Vane Pumps

- Wide pumping speed range from 1.8 to 20.5 m<sup>3</sup>/h
- Dual stage
- Forced oil circulation
- Gas ballast valve
- Anti-suckback valve and vent device



### New TPS Platform with TwisTorr FS Technology The Value of Agilent Quality

- Innovative TwisTorr molecular-drag technology with Floating Suspension
- Outstanding Reliability
- No maintenance required: Agilent Turbo Pumps don't need oil refills
- Higher compression ratio and pumping speed



### Agilent Dry Scroll Pumps

- Clean, dry primary vacuum; no maintenance required, simple tip seal replacement
- CE, UL/CUL, CSA and Semi S2-0200 certified
- Isolation valve integrated/included
- IDP-3: the smallest scroll pump in the market; peak pumping speed 3.0 m<sup>3</sup>/h, ultimate pressure 3.3 x 10<sup>-1</sup> mbar
- SH-110: peak pumping speed 5.4 m<sup>3</sup>/h
- IDP-15: quiet, low-vibration operation; pumping speed 15.4 m<sup>3</sup>/h (60 Hz), 12.8 m<sup>3</sup>/h (50 Hz); ultimate pressure 13.3 x 10<sup>-3</sup> mbar (10 mTorr)



## High Energy Physics and Research Centers

This new TPS Turbo Pumping System may be used in any laboratory where there is a need to create high vacuum in small-volume chambers quickly and easily.

The new generation electronics and the pressure display ensure the accuracy of the process.

Agilent TPS are well suited for UHV System pump down, Ion pump roughing, High Vacuum Systems operation, High and Ultra High Vacuum systems bake out.



## Electron Microscopy and Mass Spectrometry

The new TPS Integrated Turbo Pumping System are the perfect tool to keep the column of an electron microscope under vacuum while performing maintenance or repair on the device.

The oil-free nature of the dry systems guarantees freedom from contamination of the column.

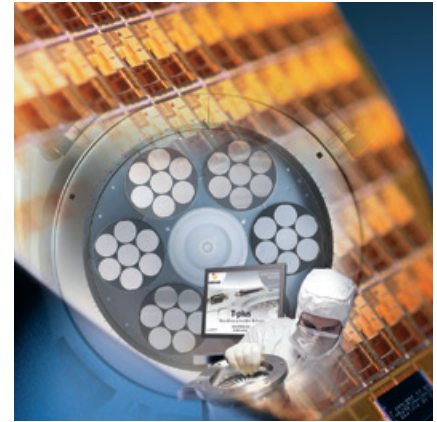

## Industrial Applications

The Agilent TPS Turbo Pumping Systems can create and maintain the required vacuum level in separate chamber of an industrial system during maintenance or repair.

The TPS with Dry Scroll Pumps are particularly well suited for evacuating load-lock chambers, or in Medical Accelerators applications. Their oil-free design ensures the purity of the process.

The TPS-mini may be mounted in any position, making it suitable for most systems.



# AGILENT TPS TURBO PUMPING SYSTEMS MODELS

## ▶ Agilent TPS-mini

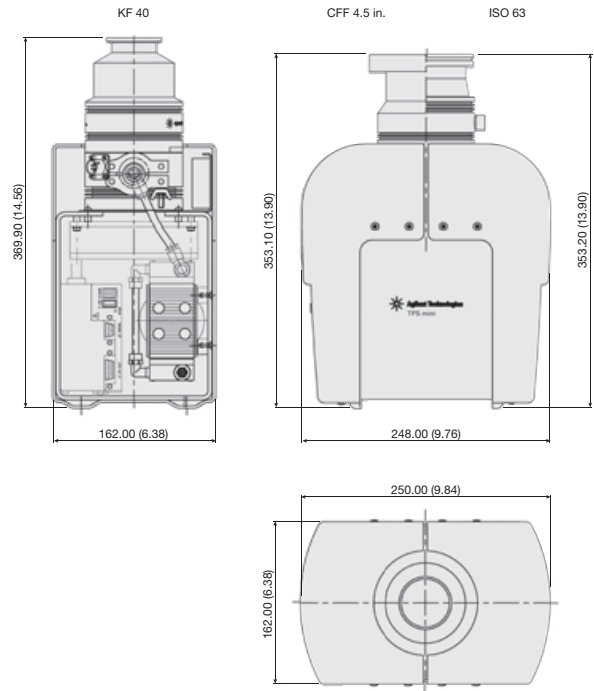

Dimensions: millimeters (inches)

A small and compact, easy-to-use, integrated dry vacuum system, featuring the new Agilent TwisTorr 84 FS Turbo Pump with improved vacuum performance, backed by a dry 10 l/min diaphragm pump. Operability in any position, no maintenance required. Active Gauge capability, large pressure display, PC connection. Universal voltage (90V/240V), CE/CSA certified.

### Features

- New generation turbomolecular pump TwisTorr 84 FS
- Smallest footprint, lightest weight, compact, dry, clean and robust system
- Universal voltage (90 V/240 V) – CE/CSA certified
- RS-232 or analogical communication
- Wide range vacuum gauge driving capability
- Large pressure data display
- Pressure driven set point, analog set point

### Benefits

- Designed for demanding applications
- Cost-effective pumping solution for small volumes
- Easy to use: plug and play system; easy PLC & PC interface
- Compatible with world-wide power configurations
- Complies with world-wide safety standards
- Easy system pressure measurement; no external gauge reading unit needed
- Direct mounting on customer's system (no vacuum pipes needed / improved conductance / HW cost saving)

### Technical Specifications

		KF40	ISO63	CFF 4 ½"
<b>Pumping speed</b> (l/s) (with inlet screen)	N <sub>2</sub>	38	52	52
	He	30	50	50
	H <sub>2</sub>	24	35	35
<b>Base pressure*</b>		2 x 10 <sup>-7</sup> mbar	2 x 10 <sup>-7</sup> mbar	5 x 10 <sup>-8</sup> mbar
<b>Bakeout temperature</b>		80 °C at inlet	80 °C at inlet	120 °C at inlet
<b>Shipping weight</b> kg (lbs. )		7.9 kg (17.4 lbs)	7.5 kg (16.4 lbs)	8.8 kg (19.4 lbs)
<b>Pumpdown time</b> (1 liter volume)		60 sec. to 17 mbar; 114 sec. to 1 x 10 <sup>-4</sup> mbar; 140 sec. to 5 x 10 <sup>-5</sup> mbar		
<b>Turbo pump rotational speed</b>		81,000 rpm		
<b>Start-up time</b>		122 sec.		
<b>Operating position</b>		Vertical, Horizontal, Upside down position		
<b>Operating ambient temperature</b>		5 °C to 35 °C / 32 °F to 122 °F		
<b>Input voltage and frequency</b>		90V to 240V AC; 50 Hz / 60 Hz		
<b>Maximum input power</b>		220 VA		
<b>Serial communications</b>		RS-232 cable, 9-pin D-type male, 9-pin D-type female, T-Plus Navigator Software		

\* According to standard DIN 28 428.

# TPS TURBO PUMPING SYSTEMS

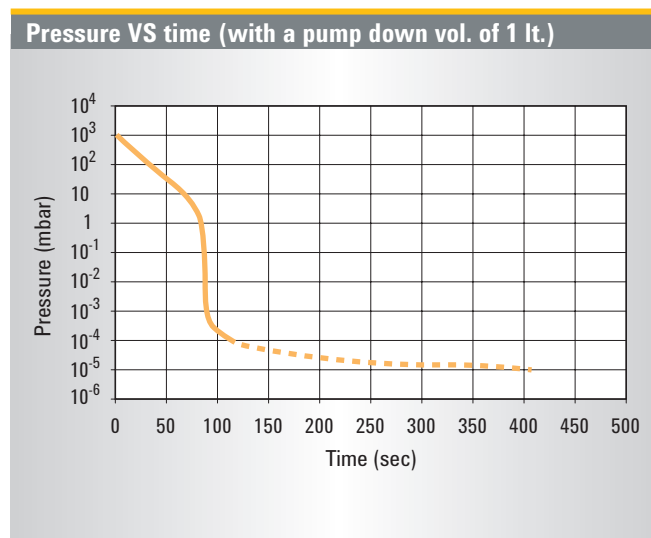
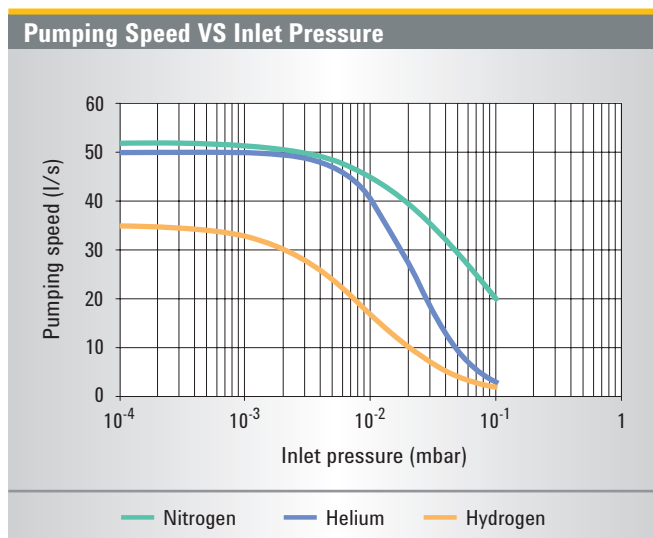

## Ordering Information

TPS-mini	KF40	IS063	CFF 4 ½"
	G8703A#020	G8703A#021	G8703A#022
<b>Accessories</b>			
DIY Full Range Gauge Kit*	9699190	9699192	9699193
Connection kit-gauge	9699180	9699181	9699182
Mains cable EU plug**, 3 meters	9699957	9699957	9699957
Mains cable NEMA plug**, 3 meters	9699958	9699958	9699958
Serial Cable and T-Plus Software***	9699883	9699883	9699883
Inlet Screen for TwisTorr 84 FS Turbo Pump	9699309	9699300	9699300

**NOTE** Special Vent Valve available on request

\* The DIY Gauge Kit can be ordered separately, and includes Full Range Gauge FRG-700, Cable for gauge connection, Vacuum Tee and Connecting Hardware (Flanges according to the System inlet flange)

\*\* Power Cord to be ordered separately

\*\*\* Software available for free download at: <http://www.chem.agilent.com/Library/software/Public/Agilent%20T-plus%201.2.4.exe.zip>

# AGILENT TPS TURBO PUMPING SYSTEMS MODELS

## ▶ Agilent TPS-compact



A portable, fully Integrated, hydrocarbon-free pumping system powered by the innovative TwisTorr 84 FS and 304 FS pumps, backed by the unique Agilent 60 l/min IDP-3 Dry Scroll, new generation primary pump: the fastest pumpdown in the market.

A cost effective pumping solution with large pressure display, Active Gauge capability, voltage 110-220 V, CE/CSA certified.

TPS-compact with  
TwisTorr 84 FS – ISO 63

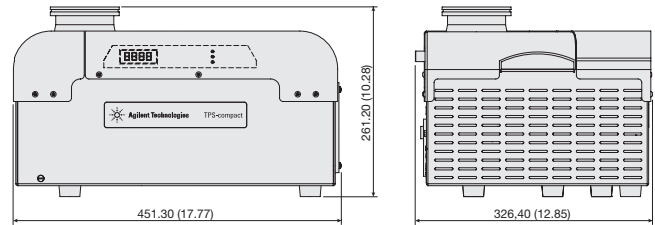

TPS-compact with  
TwisTorr 304 FS – ISO 100

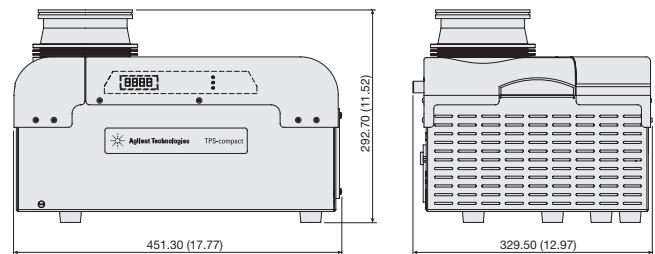

Dimensions: millimeters (inches)

### Features

- New generation TwisTorr 84 FS and 304 FS Turbomolecular Pumps
- IDP-3 Dry Scroll backing pump
- Compact, light, dry, clean and robust system
- Nominal voltage (90-240 V) - CE/CSA certified
- RS-232 or analogical communication
- Wide range vacuum gauge driving capability
- Large pressure data display
- Pressure driven set point, analog set point
- Wheels option available

### Benefits

- Designed for demanding applications
- Cost-effective pumping solution
- Easy to use: plug and play system; easy PLC & PC interface
- Complies with world-wide safety standards
- Easy system pressure measurement; no external gauge reading unit needed
- Easy Tip-seal replacement (10 min)
- Excellent base pressure, down to  $10^{-9}$  mbar
- Easy to be moved in small space
- Highest compression ratio for  $H_2/He$

### Technical Specifications

	Equipped with TwisTorr 84 FS	Equipped with TwisTorr 304 FS
<b>Pumping speed</b>	$N_2$ : 57 l/s (ISO 63, with inlet screen)*	$N_2$ : 180 l/s (with inlet screen)*
<b>Base pressure**</b>	$1 \times 10^{-9}$ mbar (CFF flanges) - $1 \times 10^{-8}$ mbar (ISO flanges)	$1 \times 10^{-9}$ mbar (CFF flanges) - $1 \times 10^{-8}$ mbar (ISO flanges)
<b>Pumpdown time</b> (15 lt volume)	46 sec (100 mbar); 104 sec (1 mbar); 160 sec ( $1 \times 10^{-4}$ mbar); 210 sec ( $5 \times 10^{-5}$ mbar); 400 sec ( $1.3 \times 10^{-5}$ mbar)	80 sec (16 mbar); 110 sec (3 mbar); 155 sec ( $6 \times 10^{-5}$ ); 200 sec ( $1 \times 10^{-5}$ )
<b>Turbo pump rotational speed</b>	80,000 RPM	60,000 RPM
<b>Start-up time</b>	144 sec.	150 sec.
<b>Operating ambient temperature</b>	5 °C to 35 °C	5 °C to 35 °C
<b>Input voltage and frequency</b>	115 Vac 60 Hz or 220-240 Vac 50/60 Hz	115 Vac 60 Hz or 220-240 Vac 50/60 Hz or 100 Vac 50/60 Hz
<b>Maximum input power</b>	260 VA	310 VA
<b>Bakeout temperature</b>	120 °C at inlet (CFF flanges) - 80 °C at inlet (KF/ISO flanges)	120 °C at inlet (CFF flanges) - 80 °C at inlet (ISO flanges)
<b>Communication</b>	RS232 - Analogical I/O	RS232 - Analogical I/O
<b>Weight</b>	16.7 kg (36.8 lbs)	20.1 kg (44.3 lbs)

\* Pump nominal speed: TwisTorr 84 FS  $N_2$ : 67 l/s; TwisTorr 304 FS  $N_2$ : 250 l/s

\*\* According to standard DIN 28 428.



# TPS TURBO PUMPING SYSTEMS

**Pumping Speed vs Inlet Pressure - TwisTorr 84 FS**

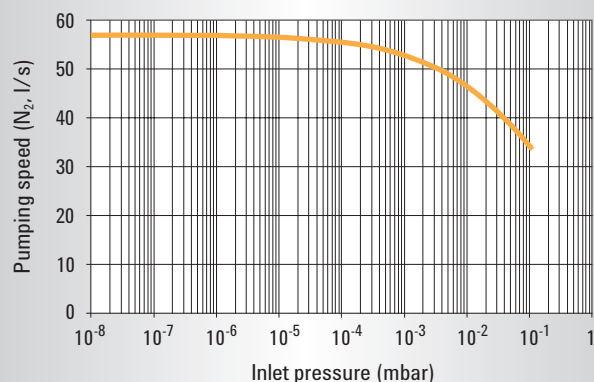

**Pressure vs Time - TwisTorr 84 FS (with a pump down vol. of 15 lt.)**

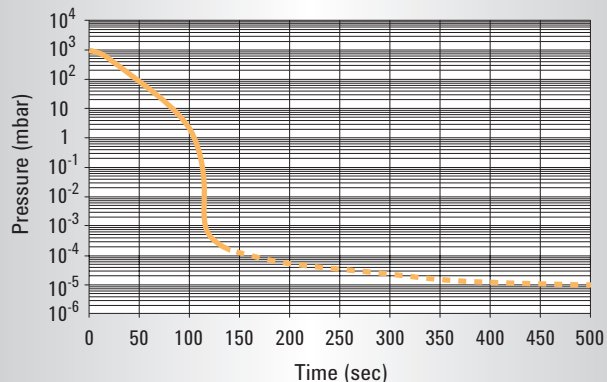

**Pumping Speed vs Inlet Pressure - TwisTorr 304 FS**

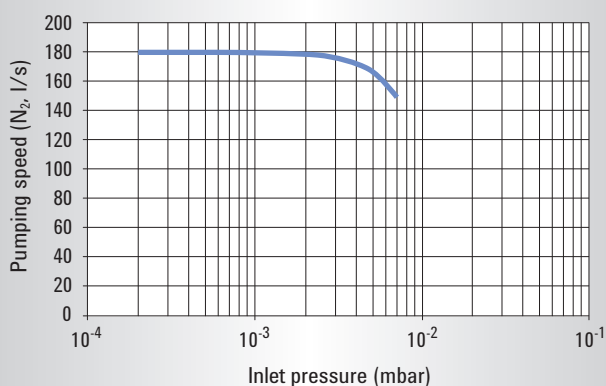

**Pressure vs Time - TwisTorr 304 FS (with a pump down vol. of 15 lt.)**

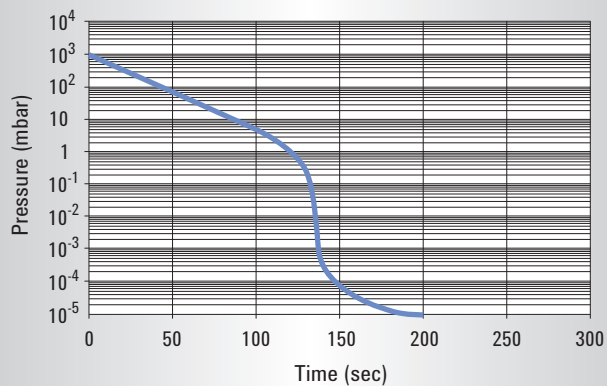

## Ordering Information

TPS-compact TwisTorr 84 FS	KF40	CFF 2 3/4"	ISO 63	CFF 4 1/2"
105 V*	X3580A#010#020#105	X3580A#010#027#105	X3580A#010#021#105	X3580A#010#022#105
120 V	X3580A#010#020#120	X3580A#010#027#120	X3580A#010#021#120	X3580A#010#022#120
220 V	X3580A#010#020#220	X3580A#010#027#220	X3580A#010#021#220	X3580A#010#022#220
<b>Accessories</b>				
Gauge Kit**	9699190	9699199	9699192	9699193
Inlet Screen	9699309	9699328	9699300	9699300
TPS-compact TwisTorr 304 FS	ISO 100	CFF 6"	ISO 160	CFF 8"
105 V*	X3580A#011#023#105	X3580A#011#024#105	X3580A#011#025#105	X3580A#011#026#105
120 V	X3580A#011#023#120	X3580A#011#024#120	X3580A#011#025#120	X3580A#011#026#120
220 V	X3580A#011#023#220	X3580A#011#024#220	X3580A#011#025#220	X3580A#011#026#220
<b>Accessories</b>				
Gauge Kit**	9699194	9699201	9699195	9699202
Inlet Screen	9699302	9699302	9699304	9699304

**NOTE** Special Vent Valve available on request

\* For Japanese market

\*\* The DIY Full Range Gauge Kit can be ordered separately, and includes Full Range Gauge FRG-700, Cable for gauge connection, Vacuum Tee and Connecting Hardware (Flanges according to the System inlet flange)

## Other Accessories

Wheels accessory kit	9698233	Mains cable NEMA plug***, 3 meters	9699958
Mains cable EU plug***, 3 meters	9699957	Serial Cable and T-Plus Software	9699883

\*\*\* Power Cord to be ordered separately

# AGILENT TPS TURBO PUMPING SYSTEMS MODELS

## ▶ Agilent TPS-bench



**TPS-bench with  
TwisTorr 84 FS and IDP-3**

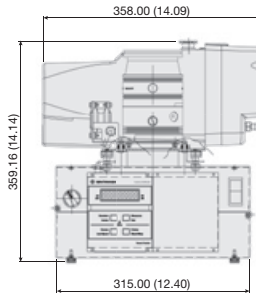

**TPS-bench with  
TwisTorr 84 FS and DS 102**

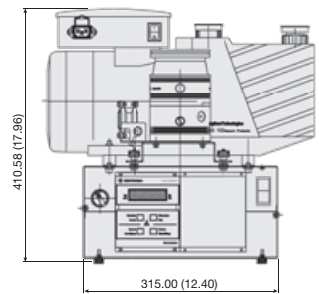

**TPS-bench with  
TwisTorr 84 FS and SH 110**

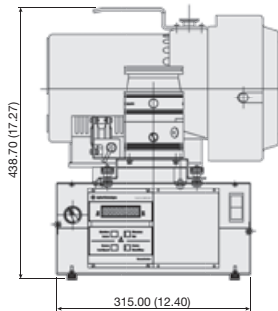

**TPS-bench with  
TwisTorr 304 FS and DS 102**

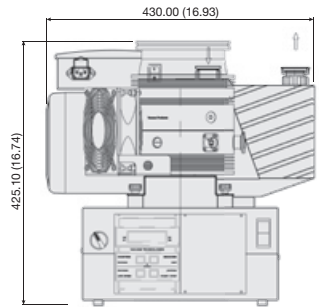

**TPS-bench with  
TwisTorr 304 FS and DS 302**

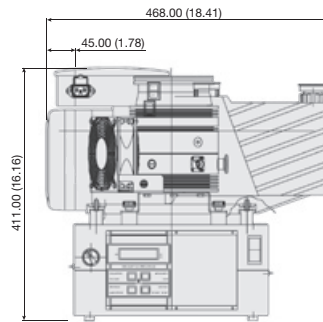

Depth: 453 (17.83)

**TPS-bench with  
TwisTorr 304 FS and SH110**

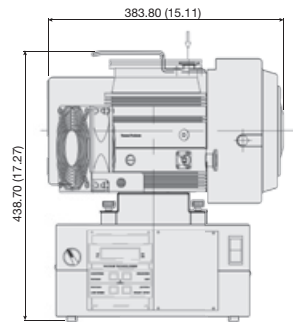

Dimensions: millimeters (inches)

Flexible table-top, compact and reliable vacuum solutions. 72 possible standard configurations with the new TwisTorr 84 FS and 304 FS Turbo Pumps, backed by Agilent Dry Scroll and Rotary Vane Pumps, ensure top vacuum performance, and fast vacuum chamber roughing. Gauges and accessories available. T-Plus Software, and Isolation valve integrated/included. Voltage 110/230V. CE, UL/CUL, CSA and Semi S2-0200 certified. Applications include UHV System pump down, Ion pump roughing, Lamp and tube processing, Cryopump regeneration, High Vacuum Systems operation, High and Ultra High Vacuum systems bake out.

## Turbomolecular Pumps - Pumping Speed

	<b>TwisTorr 84 FS</b>	<b>TwisTorr 304 FS</b>
	KF 40, ISO 63, CFF 2 3/4", CFF 4 1/2"	ISO 100, CFF 6", ISO 160, CFF 8"
<b>Pumping speed</b>	N <sub>2</sub> : 57 l/s (with inlet screen)*	N <sub>2</sub> : 180 l/s (with inlet screen)*

\* Pump nominal speed: TwisTorr 84 FS N<sub>2</sub>: 67 l/s; TwisTorr 304 FS N<sub>2</sub>: 250 l/s

## Base Pressure\*

	<b>TwisTorr 84 FS</b>	<b>TwisTorr 304 FS</b>
<b>Primary Pumps Dry</b>	5.0 x 10 <sup>-9</sup> mbar (3.75 x 10 <sup>-9</sup> Torr)	< 1.0 x 10 <sup>-10</sup> mbar (< 7.5 x 10 <sup>-11</sup> Torr)
<b>Primary Pumps Mechanical</b>	5.0 x 10 <sup>-10</sup> mbar (3.75 x 10 <sup>-10</sup> Torr)	< 1.0 x 10 <sup>-10</sup> mbar (< 7.5 x 10 <sup>-11</sup> Torr)

\* According to standard DIN 28 428

# TPS TURBO PUMPING SYSTEMS

Pressure vs Time - TwisTorr 84 FS (with a pump down vol. of 15 lt.)

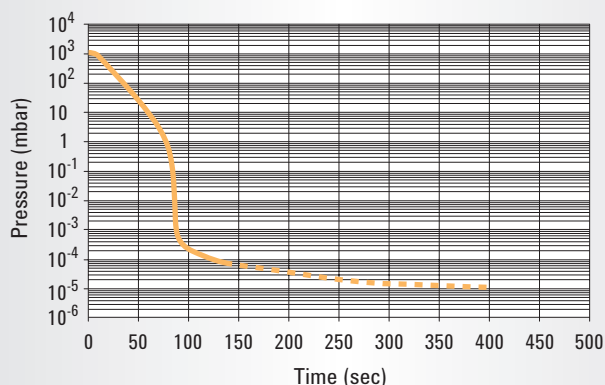

## Pumpdown Time

### TPS-bench with TwisTorr 84 FS ISO 63 and SH 110 Scroll Pump

Pumpdown time (15 liter volume) 34 sec (100 mbar); 76 sec (1 mbar); 120 sec ( $1 \times 10^{-4}$  mbar); 160 sec ( $5 \times 10^{-5}$  mbar); 400 sec ( $1 \times 10^{-5}$  mbar)

### TPS-bench with TwisTorr 304 FS ISO 100 and SH 110 Scroll Pump

Pumpdown time (15 liter volume) 40 sec (45 mbar); 60 sec (7 mbar); 80 sec ( $5 \times 10^{-1}$  mbar); 100 sec ( $8 \times 10^{-5}$  mbar); 115 sec ( $1 \times 10^{-5}$  mbar)

## TPS-bench standard configurations

TPS-bench	TwisTorr 84 FS KF40	TwisTorr 84 FS ISO 63	TwisTorr 84 FS CFF 2 3/4"	TwisTorr 84 FS CFF 4 1/2"	TwisTorr 304 FS ISO 100	TwisTorr 304 FS CFF 6"	TwisTorr 304 FS ISO 160	TwisTorr 304 FS CFF 8"
DS 102 - 120 V	•	•	•	•	•	•	•	•
DS 102 - 220 V	•	•	•	•	•	•	•	•
DS 202 - 120 V	•	•	•	•	•	•	•	•
DS 202 - 220 V	•	•	•	•	•	•	•	•
DS 302 - 120 V	•	•	•	•	•	•	•	•
DS 302 - 220 V	•	•	•	•	•	•	•	•
IDP-3 - 120 V	•	•	•	•				
IDP-3 - 220 V	•	•	•	•				
SH 110 - 120 V	•	•	•	•	•	•	•	•
SH 110 - 220 V	•	•	•	•	•	•	•	•

Ordering Information available on request: call Agilent for details

## Turbomolecular Pumps

Turbo Pump Model	Inlet Flange
TwisTorr 84 FS Pump	ISO 63, KF 40*, CFF 2 3/4", CFF 4 1/2"
TwisTorr 304 FS Pump	ISO 100, CFF 6", ISO 160, CFF 8"

\* Configuration available on request

## Primary Pumps

Dry Scroll Pumps	Peak Pumping Speed 50 Hz
SH 110, single phase	90 l/min - 5.4 m <sup>3</sup> /h - 3.3 cfm
IDP-3, single phase	50 l/min - 3.0 m <sup>3</sup> /h - 1.8 cfm

Rotary Vane Dual Stage Pumps	Pumping Speed 50 Hz
DS 102 - 1 phase worldwide motor	5.0 m <sup>3</sup> /h
DS 202 - 1 phase worldwide motor	8.3 m <sup>3</sup> /h
DS 302 - 1 phase worldwide motor	11.6 m <sup>3</sup> /h

## AGILENT TPS TURBO PUMPING SYSTEMS MODELS

### ▶ Agilent TPS-bench (Cont'd)

#### Managing Gauges

GAUGE KIT	Inlet Flange	DIY FRG-700 Full Range Gauge Kit (atmosphere to $3.8 \times 10^{-9}$ Torr)
TwisTorr 84 FS	KF 40	9699190
	ISO 63	9699192
	CFF 2 3/4"	9699199
	CFF 4 1/2"	9699193
TwisTorr 304 FS	ISO 100	9699194
	CFF 6"	9699201
	ISO 160	9699195
	CFF 8"	9699202

For other gauge configurations, please contact your local Agilent representative.

#### Cables

Power cords are included free of charge in all TPS-bench and TPS-mobile models, with US, EU or UK plug.



# TPS TURBO PUMPING SYSTEMS

## ▶ Agilent TPS-mobile



TPS-mobile with  
TwisTorr 304 FS and IDP-15

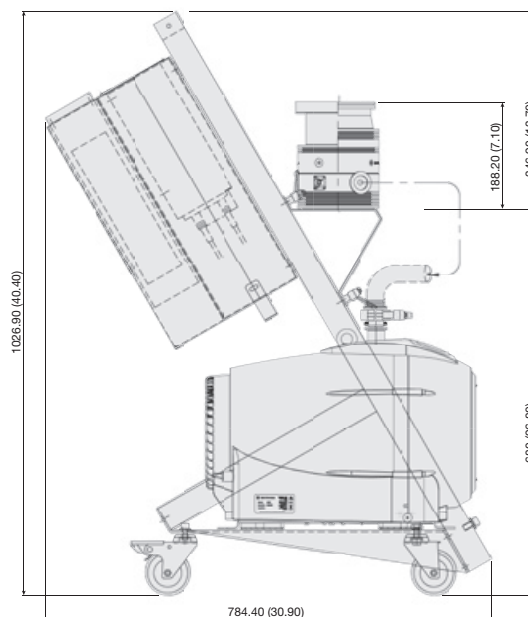

Width: 422 (16.61)

Dimensions: millimeters (inches)

Roll-around cart, high capacity systems, with higher compression ratio and wide pumping speed range. 160 possible configurations, with the new TwisTorr 84 FS and 304 FS, and the Turbo-V 551 Navigator Turbo Pumps, backed by Agilent Dry Scroll Pumps (including the new IDP-15) or DS Mechanical Pumps. Large selection of gauges and accessories available for customized solutions.

T-Plus Software, Isolation valve integrated/included. Voltage 110/230V. CE, UL/CUL, CSA and Semi S2-0200 certified.

Applications include UHV System pump down, Ion pump roughing, Lamp and tube processing, Cryopump regeneration, High Vacuum Systems operation, High and Ultra High Vacuum systems bake out.

## Turbomolecular Pumps - Pumping Speed\*

	TwisTorr 84 FS	TwisTorr 304 FS	Turbo-V 551 Navigator
	KF 40, ISO 63, CFF 2 3/4", CFF 4 1/2"	ISO 100, CFF 6", ISO 160, CFF 8"	ISO 100, CFF 6", ISO 160, CFF 8"
<b>Pumping speed</b>	N <sub>2</sub> : 57 l/s (with inlet screen)*	N <sub>2</sub> : 180 l/s (with inlet screen)*	N <sub>2</sub> : 550 l/s (with inlet screen)

\* Pump nominal speed: TwisTorr 84 FS N<sub>2</sub>: 67 l/s; TwisTorr 304 FS N<sub>2</sub>: 250 l/s.

## Base Pressure

	TwisTorr 84 FS	TwisTorr 304 FS	Turbo-V 551 Navigator
<b>With SH110 Dry Scroll Pump</b>	5.0 x 10 <sup>-9</sup> mbar (3.75 x 10 <sup>-9</sup> Torr)	< 1.0 x 10 <sup>-10</sup> mbar (< 7.5 x 10 <sup>-11</sup> Torr)	< 1.0 x 10 <sup>-10</sup> mbar (< 7.5 x 10 <sup>-11</sup> Torr)
<b>With DS-102 Rotary Vane Pump</b>	5.0 x 10 <sup>-10</sup> mbar (3.75 x 10 <sup>-10</sup> Torr)	< 1.0 x 10 <sup>-10</sup> mbar (< 7.5 x 10 <sup>-11</sup> Torr)	< 1.0 x 10 <sup>-10</sup> mbar (< 7.5 x 10 <sup>-11</sup> Torr)

\* According to standard DIN 28 428

# AGILENT TPS TURBO PUMPING SYSTEMS MODELS

## ▶ Agilent TPS-mobile (Cont'd)

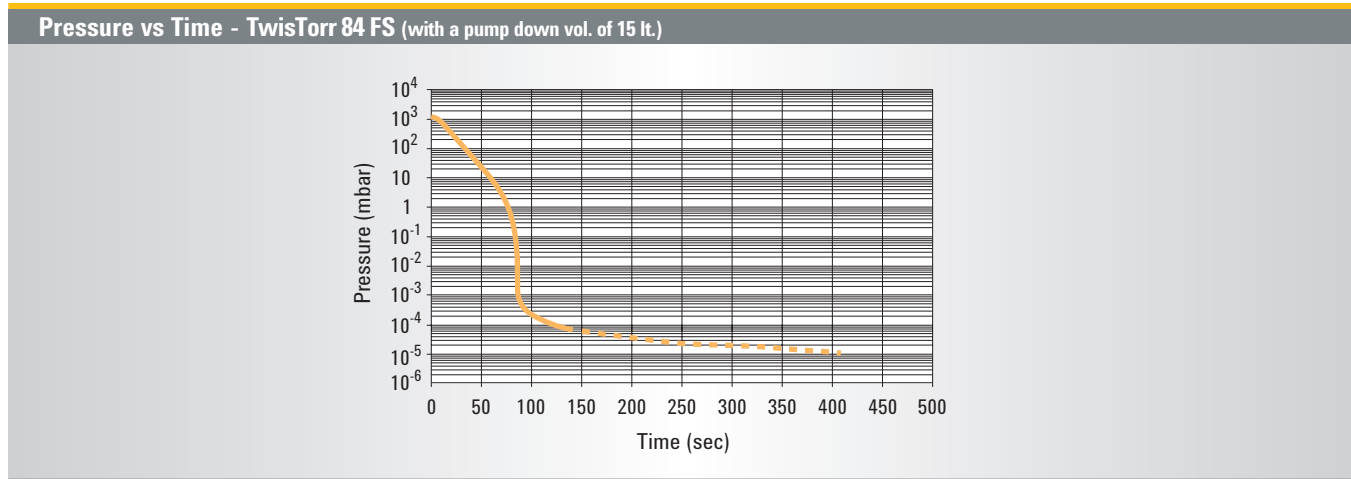

### Pumpdown Time

#### TPS-mobile with TwisTorr 84 FS ISO 63 and SH 110 Scroll Pump

Pumpdown time (15 liter volume) 34 sec (100 mbar); 76 sec (1 mbar); 120 sec ( $1 \times 10^{-4}$  mbar); 160 sec ( $5 \times 10^{-5}$  mbar); 400 sec ( $1 \times 10^{-5}$  mbar)

#### TPS-mobile with TwisTorr 304 FS ISO 100 and SH 110 Scroll Pump

Pumpdown time (15 liter volume) 40 sec (50 mbar); 60 sec (8 mbar); 80 sec ( $7 \times 10^{-1}$  mbar); 100 sec ( $1 \times 10^{-4}$  mbar); 130 sec ( $1 \times 10^{-5}$  mbar)

### TPS-mobile standard configurations

TPS-compact	TwisTorr 84 FS KF40	TwisTorr 84 FS ISO 63	TwisTorr 84 FS CFF 2 3/4"	TwisTorr 84 FS CFF 4 1/2"	TwisTorr 304 FS ISO 100	TwisTorr 304 FS CFF 6"	TwisTorr 304 FS ISO 160	TwisTorr 304 FS CFF 8"	TV 551 ISO 100	TV 551 CFF 6"	TV 551 ISO 160	TV 551 CFF 8"
DS 102 - 120 V	•	•	•	•	•	•	•	•				
DS 102 - 220 V	•	•	•	•	•	•	•	•				
DS 202 - 120 V	•	•	•	•	•	•	•	•				
DS 202 - 220 V	•	•	•	•	•	•	•	•				
DS 302 - 120 V					•	•	•	•	•	•	•	•
DS 302 - 220 V					•	•	•	•	•	•	•	•
DS 402 - 120 V					•	•	•	•	•	•	•	•
DS 402 - 220 V					•	•	•	•	•	•	•	•
DS 602 - 120 V					•	•	•	•	•	•	•	•
DS 602 - 220 V					•	•	•	•	•	•	•	•
IDP-3 - 120 V	•	•	•	•	•	•	•	•				
IDP-3 - 220 V	•	•	•	•	•	•	•	•				
SH 110 - 120 V	•	•	•	•	•	•	•	•				
SH 110 - 220 V	•	•	•	•	•	•	•	•				
IDP-15 - 120 V					•	•	•	•	•	•	•	•
IDP-15 - 220 V					•	•	•	•	•	•	•	•
TS 300 VPI - 120 V					•	•	•	•	•	•	•	•
TS 300 VPI - 220 V					•	•	•	•	•	•	•	•
TS 600 VPI - 120 V					•	•	•	•	•	•	•	•
TS 600 VPI - 220 V					•	•	•	•	•	•	•	•

Ordering Information available on request: call Agilent for details

# TPS TURBO PUMPING SYSTEMS

## Turbomolecular Pumps

Turbo Pump Model	Inlet Flange
TwisTorr 84 FS Pump	ISO 63, KF 40*, CFF 2 3/4", CFF 4 1/2"*
TwisTorr 304 FS Pump	ISO 100, CFF 6", ISO 160, CFF 8"*
Turbo-V 551 Navigator	ISO 100, CFF 6", ISO 160, CFF 8"*

\* Configuration available on request

## Primary Pumps

Dry Scroll Pumps	Peak Pumping Speed 50 Hz
IDP-3, single phase	50 l/min - 3.0 m <sup>3</sup> /h - 1.8 cfm
SH 110, single phase	90 l/min - 5.4 m <sup>3</sup> /h - 3.3 cfm
TriScroll 300, single phase, with Vacuum Pump Isolation Valve (VPI)	210 l/min 12.6 m <sup>3</sup> /h - 7.4 cfm
TriScroll 600, single phase, with Vacuum Pump Isolation Valve (VPI)	420 l/min 25.2 m <sup>3</sup> /h - 14.8 cfm
IDP-15, single phase	214 l/min 12.8 m <sup>3</sup> /h - 7.5 cfm

Rotary Vane Dual Stage Pumps	Pumping Speed 50 Hz
DS 102 - 1 phase worldwide motor	5.0 m <sup>3</sup> /h
DS 202 - 1 phase worldwide motor	8.3 m <sup>3</sup> /h
DS 302 - 1 phase worldwide motor	11.6 m <sup>3</sup> /h
DS 402 - 1 phase worldwide motor	17.4 m <sup>3</sup> /h
DS 602 - 1 phase worldwide motor	25.0 m <sup>3</sup> /h

## Managing Gauges

GAUGE KIT	Inlet Flange	DIY FRG-700 Full Range Gauge Kit (atmosphere to 3.8 x 10 <sup>-9</sup> Torr)
TwisTorr 84 FS	KF 40	9699190
	ISO 63	9699192
	CFF 4 1/2"	9699193
TwisTorr 304 FS and Turbo-V 551 Navigator	ISO 100	9699194
	CFF 6"	9699201
	ISO 160 K	9699195
	CFF 8"	9699202

For other gauge configurations, please contact your local Agilent representative.

## Cables

Power cords are included free of charge in all TPS-bench and TPS-mobile models, with US, EU or UK plug.